

**Note: This analysis and some exhibits have been revised since the version mailed for the July ZBA meeting.**

**CITY OF SUWANEE  
VARIANCE ANALYSIS**

**CASE NUMBER(S):** V-2008-011, V-2008-012, V-2008-013  
**REQUEST(S):** V-2008-011 – GROUND SIGN EXCEEDING SIZE AND HEIGHT ALLOWANCES  
V-2008-012 – GROUND SIGN EXCEEDING SIZE AND HEIGHT ALLOWANCES  
V-2008-013 – GROUND SIGN EXCEEDING SIZE & HEIGHT ALLOWANCES  
**APPLICABLE SECTION:** V-2008-011: SECTION 1612.C.3(a)  
V-2008-012: SECTION 1612.C.3(a)  
V-2008-013: SECTION 1612.C.2(a)  
**LOCATION:** 1120 PEACHTREE INDUSTRIAL BLVD /  
4065 MCGINNIS FERRY ROAD, SOUTHWEST CORNER.  
**DISTRICT/LAND LOT/PARCEL:** 7-238-001  
**ZONING:** C-3 (SPECIAL COMMERCIAL DISTRICT)  
**DEVELOPMENT:** RETAIL SHOPPING CENTER  
  
**APPLICANT:** DEVELOPMENT CONSULTANTS GROUP  
2400 MEADOWBROOK PARKWAY  
DULUTH, GA  
  
**OWNER:** GWINNETT PRADO, LP  
P.O. BOX 957209  
DULUTH, GA  
  
**CONTACT:** DOT YOUNT      PHONE: 678-812-4371  
  
**RECOMMENDATION:**      **APPROVAL WITH CONDITIONS**

**ANAYLSIS:**

The applicant seeks a variance from Section 1612 of the City of Suwanee Zoning Ordinance to allow for two ground signs for a retail shopping center and one ground sign for a bowling alley which exceed the allowable height and sign area requirements. The subject site is located within a 19.8 acre commercial development at the intersection of Peachtree Industrial Boulevard and McGinnis Ferry Road. The 36,700 square foot retail shopping complex is currently under construction. The 50,126 square foot bowling alley is currently under development review. Access is available onto Peachtree Industrial Boulevard and McGinnis Ferry Road. Currently, both projects are located on a single tract. However, the owner is currently in the process of subdividing the tract. When approved, this plat will place the two projects on separate lots. Therefore, the applicant is entitled to one ground sign per road frontage for the shopping center. One ground sign is proposed on Peachtree Industrial Boulevard (V-2008-012) and one is

proposed on McGinnis Ferry Road (V-2008-011). For the bowling alley, which is an individual establishment on an individual lot, one ground sign is allowed. This ground sign is proposed along Peachtree Industrial Boulevard (V-2008-013).

Section 1612.C.2 & 3 of the zoning ordinance regulate the size of ground signs for shopping centers and the size of ground signs for individual establishments based upon the gross square footage of each project. The proposed shopping center ground signs (V-2008-011/012) fall into the 10,001 to 50,000 square foot range. Projects within this range are allowed one ground sign per road frontage with a maximum copy area of 80 square feet and a maximum sign area of 104 square feet. The shopping center fronts on two roads and is permitted to erect two ground signs. The proposed bowling alley ground sign (V-2008-013) falls into the 50,001 square foot to 100,000 square foot range. Projects within this range are allowed one ground sign per road frontage with a maximum copy area of 64 square feet and a maximum sign area of 104 square feet. (Note: copy area refers to the text/message while sign area refers to the overall sign structure minus the base)

The sign ordinance also regulates the height of signs based on the distance they are setback from the right-of-way. A sign with a setback of 0 to 5 feet may be 6 feet tall. All three signs fall into this range since they are proposed to be located 0 feet from the right-of-way.

**V-2008-011 and V-2008-012:** The applicant proposes two ground signs for a shopping center setback 0 feet from the McGinnis Ferry Road and Peachtree Industrial Boulevard rights-of-way. Both signs are 14 feet tall with 163 square feet of overall sign area. These signs exceed the overall permitted height by 8 feet and the overall permitted sign area by 59 square feet. Variances are required in order to construct the signs as proposed.

**V-2008-013:** The applicant proposes a ground sign for an individual establishment on an individual lot setback 0 feet from the Peachtree Industrial Boulevard right-of-way. The sign is 14 feet tall with 136 square feet of sign area. The sign exceeds the overall permitted height by 8 feet and the overall permitted sign area by 32 square feet. A variance is required in order to construct the sign as proposed.

The applicant states that sign area increases are necessary in order to achieve a desired level of architectural integrity. Height increases for **V-2008-012 & 013** are requested by the applicant due to the existing right-of-way width of Peachtree Industrial Boulevard. The applicant also states that the sign on McGinnis Ferry Road (**V-2008-011**) is constrained by the location of a sanitary sewer easement located approximately 13.5 feet off the right-of-way. According to the applicant, this results in a limited buildable area for the proposed sign and the need for an increase in sign height to create a more desirable sign. If the sewer easement were not located near the right of way, then the sign could be setback further from the road, which would allow for a taller sign. For all three requests, the applicant states that the height increase is necessary in order to achieve the allowable copy area for the signs. The applicant also states that they wish to have a consistent and uniform sign style that matches the architecture of the shopping center

The subject property is located at the highly commercialized McGinnis Ferry Road / Peachtree Industrial Boulevard intersection, at the center of a 19.98-acre commercial project. To the west

of the subject property are a bank (zoned C-3), a drug store (zoned C-3), and Peachtree Industrial Boulevard. Across Peachtree Industrial Boulevard, further west, is a shopping center and several outparcels, zoned a combination of C-2 and C-2A. To the south of the subject property is a 6.88 acre tract (C-3) that is undeveloped and preserved as part of the Metropolitan River Protection Act restrictions. To the west of the subject property is an apartment complex zoned RM-8. To the west of the subject property, across McGinnis Ferry Road, is a large retail shopping center and outparcels all zoned C-3.

When Peachtree Industrial Boulevard was widened from two lanes to four lanes, the state significantly widened the right-of-way in front of the subject property. This widening forces the applicant to place ground signs a significant distance from the actual travel lanes. The proposed sign for the bowling alley (V-2008-013) is located approximately 115 feet from the nearest Peachtree Industrial Boulevard travel lane. The proposed sign for the shopping center (V-2008-012) is located approximately 108 feet from the nearest Peachtree Industrial Boulevard travel lane. It should be noted that the wide right-of-way contributed to a variance being approved for Epiphany Lutheran Church in February of 2004 (V-2004-002), two sign variances for the Suwanee Jubilee project (V-2005-008 and 009), and a sign variance for the Plaza at Suwanee Station in April of 2007 (V-2007-014). Regarding V-2008-011, the site is constrained by the existence of a sewer line which is not allowed to contain a sign.

The City of Suwanee's Zoning Ordinance grants the Zoning Board of Appeals the authority to grant variances. According to Section 2006 of the Ordinance, the Board is authorized to grant variances when literal enforcement of the Ordinance will result in an unnecessary hardship to a property owner. The zoning ordinance also states that variances may be granted when, "relief, if granted, would not cause substantial detriment to the public good nor impair the purposes or intent of the Zoning Ordinance."

### **Recommendation**

In conclusion, the subject property does appear to have a situation that causes some hardship, although the site constraint caused by the location of the sanitary sewer easement along McGinnis Ferry Road and the wide right-of-way along Peachtree Industrial Boulevard does not inhibit implementation of the regulations. However, the applicant is proposing to deviate from the requirements for a logical site design reason and aesthetics. The applicant has a desire to create a sense of symmetry with the signs located on Peachtree Industrial Boulevard and the building architecture. The city has approved similar variance requests along Peachtree Industrial Boulevard. With conditions to ensure the scope of the variances are limited, approval is appropriate. Therefore, staff recommends **APPROVAL WITH CONDITIONS** of V-2008-011, V-2008-012 and V-2008-013.

Planning Department  
Recommended Conditions  
**V-2008-011, V2008-012**

Approval of variances for increases in ground sign height and size subject to the following conditions:

1. The ground sign shall be located approximately as indicated on the Overall Site Plan submitted with the variance application and constructed similarly to the submitted variance exhibit "A".
2. Ground signs shall not be internally illuminated.

Planning Department  
Recommended Conditions  
**V2008-013**

Approval of variances for increases in ground sign height and size subject to the following conditions:

1. The ground sign shall be located approximately as indicated on the Overall Site Plan submitted with the variance application and constructed similarly to the submitted variance exhibit "A".
2. Ground signs shall not be internally illuminated.

## Standards for Consideration

**Pursuant to Section 2009A of the City of Suwanee Zoning Ordinance, the City finds the following standards are relevant in considering all applications for a Variance.**

- A. Will approval of the variance unreasonably increase the congestion in public streets?**

Approval of this variance would not increase the congestion in public streets.

- B. Will approval increase the danger of fire or endanger public safety?**

Approval of this variance would not increase the danger of fire or endanger public safety if the sign is located appropriately. A professional engineer will need to stamp the construction plans for the sign to ensure that it is properly designed.

- C. Will approval unreasonably diminish or impair established property values within the surrounding area?**

Approval of the variances would not unreasonably diminish or impair property values within the surrounding area.

- D. Will approval in any other aspect impair the public health, safety, comfort, morals or welfare of the inhabitants of the City?**

Approval of this variance would not impair the public health, safety, comfort, morals, or welfare.

Sign # 1 - Shoppes at McGinnis Crossing  
(Note - this signage to include verbiage for Brunswick as well as Shoppes ....)

**APPLICATION FOR VARIANCE FROM THE  
CITY OF SUWANEE ZONING BOARD OF APPEALS**

Please complete this application and submit with all necessary attachments as stated on the Variance Information Form (please type or print)

APPLICANT INFORMATION

OWNER INFORMATION

Name: Development Consultants Group Name: Gwinnett Prado, LP  
Address: 2400 Meadowbrook Parkway Address: P.O. Box 957209  
City: Duluth City: Duluth  
State: GA State: GA  
Phone: 770-279-1710 Phone: 770-476-4801

CONTACT PERSON: Dot Yount PHONE: 678-812-4371 direct line

ADDRESS OF PROPERTY Southwest quadrant @ McGinnis Ferry Rd &

LAND DISTRICT 7 LAND LOT 238 PARCEL 001 LOT Peachtree Ind. Bl

SUBDIVISION OR PROJECT NAME (IF APPLICABLE) McGinnis Crossing

ZONING C-3

VARIANCE REQUESTED Signage - ① Sign Area increase  
② Sign height increase

NEED FOR VARIANCE ① Sign area increase to achieve desired architectural integrity

② Sign height increase - due to limited buildable area 13.6' from McGinnis Ferry R.O.W. & 20' existing Sanitary Sewer Easement req'd to exceed min ht at zero setback - 13' base - To achieve allowed copy area/signage height needs to increase

**\*A VARIANCE FROM A CONDITION OF ZONING CANNOT BE ACCEPTED SECTION 2007, APPLICANT AND/OR A REPRESENTATIVE.**  
**\*\*\*The property owner, applicant and/or a representative thereof shall be present at all meetings of the Zoning Board of Appeals, Planning Commission and/or Mayor and Council at which official action is requested on any variance or application for amendment. The failure of the property owner, applicant and/or a representative to attend such meetings shall result in the denial of said variance or application for amendment.** increase see sketches

**V-2008-011**

Note: Property in Process of being final platted,

Sign # 2 - Shoppes at McGinnis Crossing

APPLICATION FOR VARIANCE FROM THE CITY OF SUWANEE ZONING BOARD OF APPEALS

Please complete this application and submit with all necessary attachments as stated on the Variance Information Form (please type or print)

APPLICANT INFORMATION

OWNER INFORMATION

Name: Development Consultancy Group
Address: 2400 Meadowbrook Parkway
City: Duluth
State: GA
Phone: 770-299-1710

Name: Gwinnett Prado, LP
Address: P.O. Box 957209
City: Duluth
State: GA
Phone: 770-476-4801

CONTACT PERSON: Dot Yount

PHONE: 678-812-4371 direct line

ADDRESS OF PROPERTY S.W. quad of Int. McGinnis Ferry Rd & P.I.B

LAND DISTRICT 7 LAND LOT 238 PARCEL 001 LOT

SUBDIVISION OR PROJECT NAME (IF APPLICABLE) McGinnis Crossing

ZONING C-3

VARIANCE REQUESTED Signage - 1 Sign Area Increase
2 Sign Height increase

NEED FOR VARIANCE 1 Sign Area Increase - to achieve desired architectural integrity

2 Sign height increase based on (consistent signage for development) sign # 1 length @ 13' req'd height increase at zero setback to achieve allowed copy area, etc... - Signage to be placed at zero setback due

\*A VARIANCE FROM A CONDITION OF ZONING CANNOT BE ACCEPTED. SECTION 2007, APPLICANT AND/OR A REPRESENTATIVE.

\*\*\*The property owner, applicant and /or a representative thereof shall be present at all meetings of the Zoning Board of Appeals, Planning Commission and/or Mayor and Council at which official action is requested on any variance or application for amendment. The failure of the property owner, applicant and/or a representative to attend such meetings shall result in the denial of said variance or application for amendment.

excessive width of P.I.B. Row and distance from Street.

V-2008-012

Note: Property in Process of being final platted

Sign # 3 - Brunswick Signage that will also contain verbage for Shoppes etc...

APPLICATION FOR VARIANCE FROM THE CITY OF SUWANEE ZONING BOARD OF APPEALS

Please complete this application and submit with all necessary attachments as stated on the Variance Information Form (please type or print)

APPLICANT INFORMATION

OWNER INFORMATION

Name: Development Consultants Group Name Gwinnett Prods, LP
Address: 2400 Meadowbrook Parkw. Address P.O. Box 957209
City: Duluth City: Duluth
State: GA State GA
Phone: 170-279-1710 Phone: 170-476-4801

CONTACT PERSON: Dot Yount PHONE: 678-812-4371 direct line

ADDRESS OF PROPERTY S.W. quad of Intersect of McGinnis Ferry Rd

LAND DISTRICT 7 LAND LOT 238 PARCEL 001 LOT P.I.B.

SUBDIVISION OR PROJECT NAME (IF APPLICABLE) McGinnis Crossing

ZONING C-3

VARIANCE REQUESTED Signage - 1 Sign Area increase
2 Sign height increase

NEED FOR VARIANCE 1 Sign area increase - to achieve architect integrity and remain consistent with 'Shoppes' signage. Sign area allowed for ind. bldg on ind lot same as allowed for Shoppes... Signage... 2 Sign height increase maintain same consistent signage as Sign # 1. Signage will be placed at zero setback due to great width of P.I.B.

\*A VARIANCE FROM A CONDITION OF ZONING CANNOT BE ACCEPTED. SECTION 2007, APPLICANT AND/OR A REPRESENTATIVE. \*\*\*The property owner, applicant and /or a representative thereof shall be present at all meetings of the Zoning Board of Appeals, Planning Commission and/or Mayor and Council at which official action is requested on any variance or application for amendment. The failure of the property owner, applicant and/or a representative to attend such meetings shall result in the denial of said variance or application for amendment. P.I.B. and distance from street

V-2008-013

Note: Property in Process of being final plattd, currently in Review



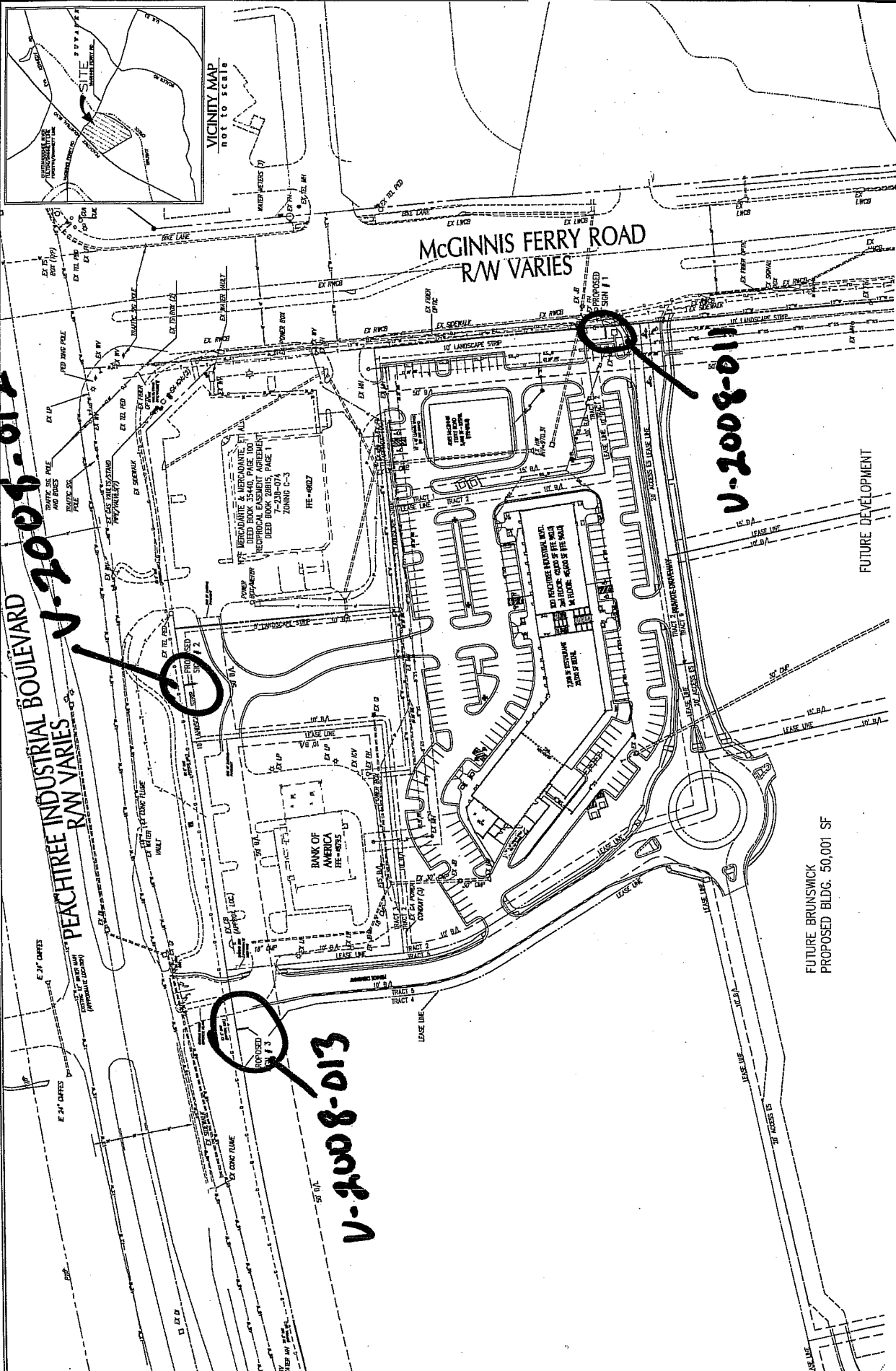

McGINNIS CROSSING  
 PHASE III  
 CIVIL ENGINEER  
 CITY OF SIMMONS  
 SIMMONS COUNTY, GA  
 COUNTY ENGINEER  
 DATE: 08/11/11  
 DRAWN: M.A./D.T.  
 JOB # 110808-012

McGINNIS CROSSING  
 PHASE III  
 CIVIL ENGINEER  
 CITY OF SIMMONS  
 SIMMONS COUNTY, GA  
 COUNTY ENGINEER  
 DATE: 08/11/11  
 DRAWN: M.A./D.T.  
 JOB # 110808-012

McGINNIS CROSSING  
 PHASE III  
 CIVIL ENGINEER  
 CITY OF SIMMONS  
 SIMMONS COUNTY, GA  
 COUNTY ENGINEER  
 DATE: 08/11/11  
 DRAWN: M.A./D.T.  
 JOB # 110808-012

McGinnis Ferry Rd

V-2008-01

Peachtree Industrial Blvd.

V-2008-012

V-2008-013

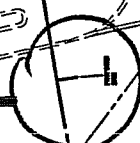
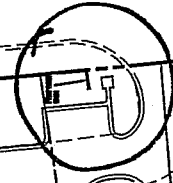

Private Drive

Sign Locations of 1-3

3

2

1

City of Suwanee

CROSSROADS of PAST and FUTURE



CITY OF  
**Suwanee**  
G E O R G I A

V-2008-011  
V-2008-012  
V-2008-013

Location Map

**Legend**

— Streets

City Limits

v-2008-011/012/013

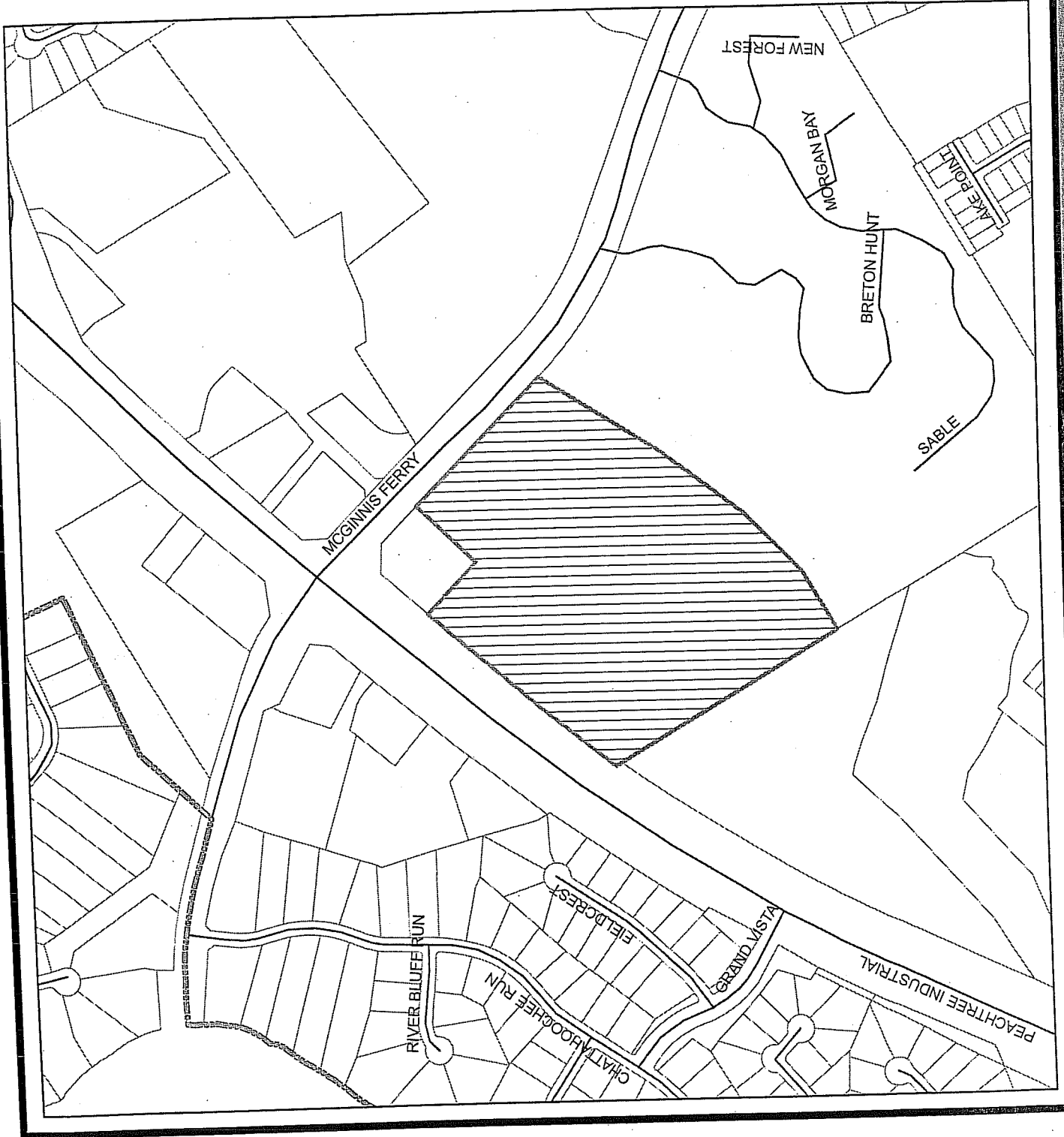
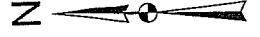

**VARIANCE EXHIBIT(S):**

**V-2008-011**

**V-2008-012**

McGinnis Ferry Rd.

sign location

# 1

V-2008-011

13.6'  
clearance  
betw/  
RW &  
SSE

Existing 20'  
Sanitary Sewer Easement  
EX 20' SSE

EX 20' SSE

Private Drive

V-2008-011

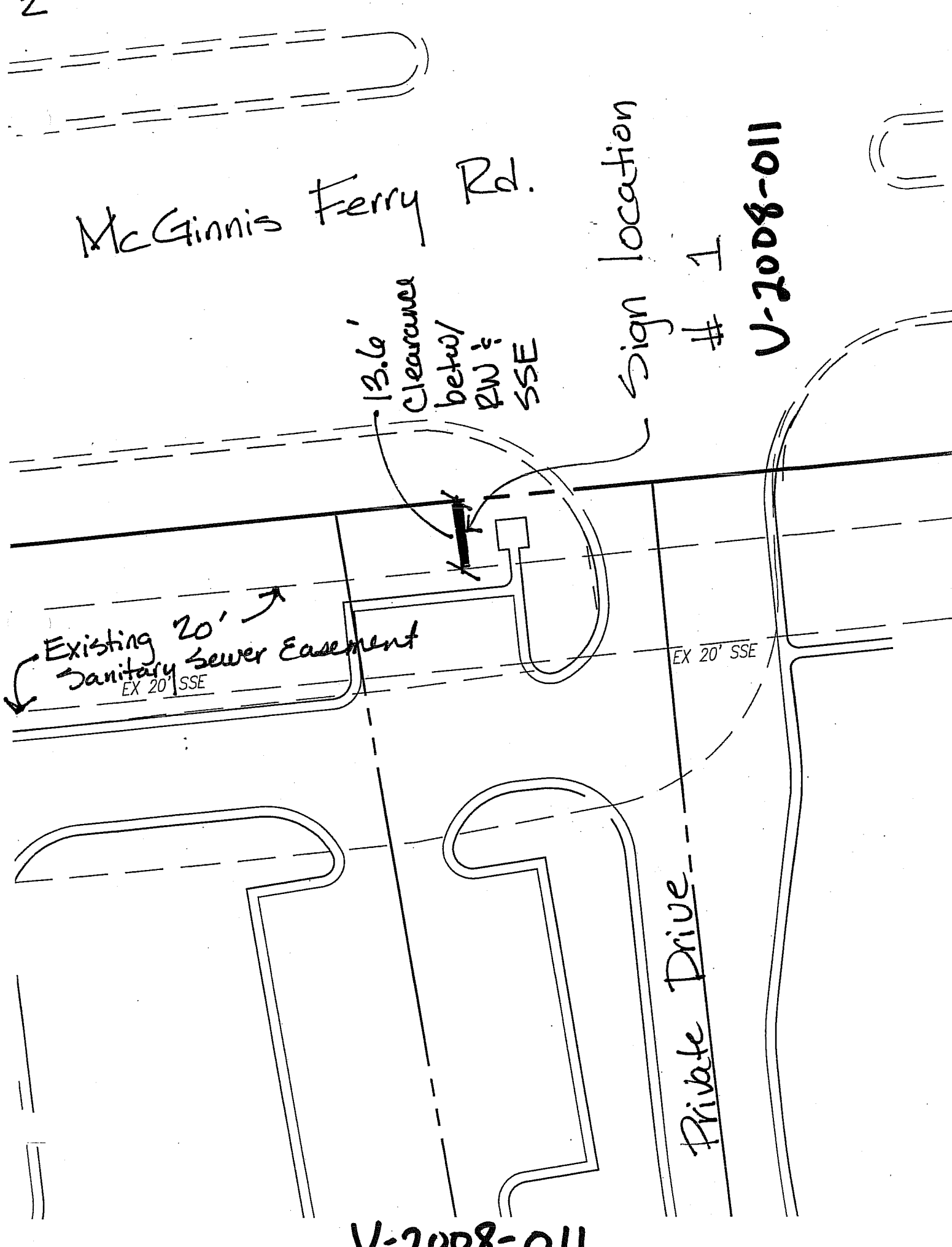

REGULATIONS MET AT 5.1' SETBACK  
SHOPPES AT MCGINNIS CROSSING SIGNAGE

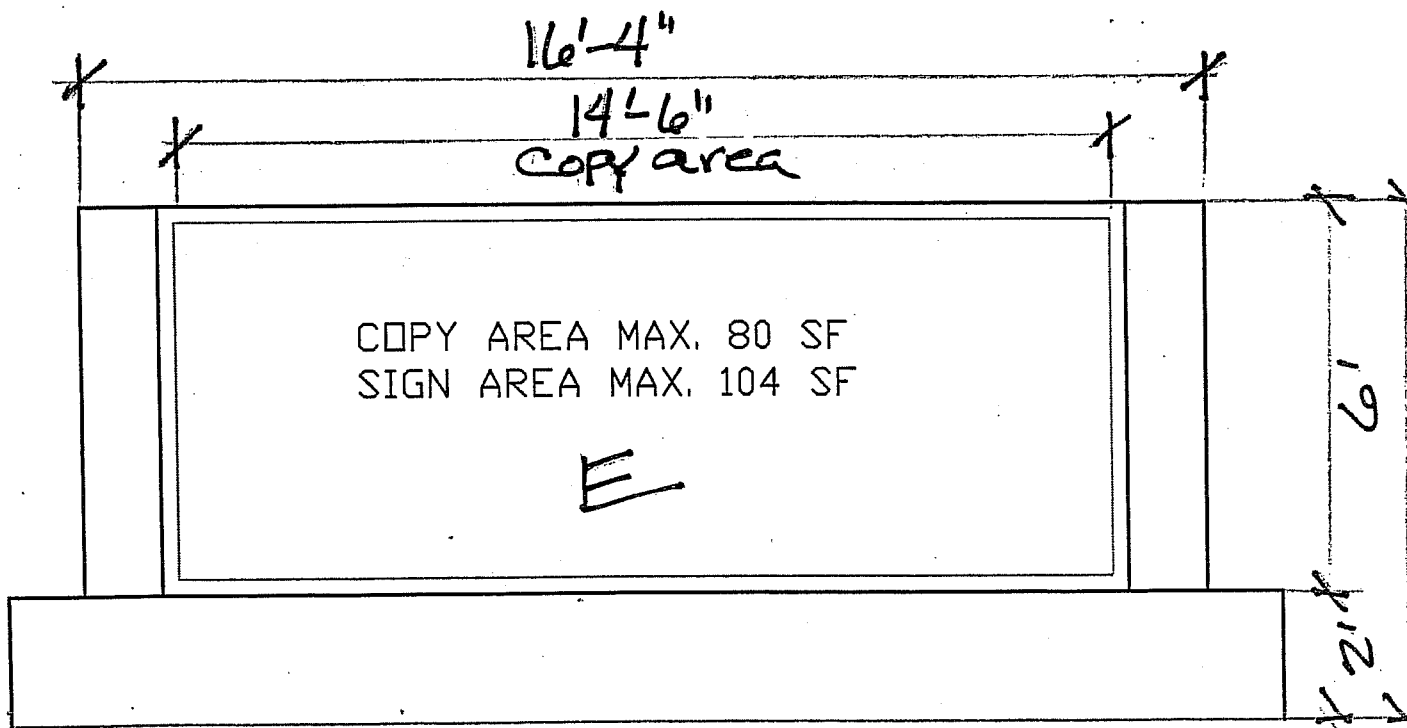

U-2008-011 + 012

1" = 30'

REGULATIONS MET AT 20' SETBACK  
SHOPPES AT MCGINNIS CROSSING SIGNAGE

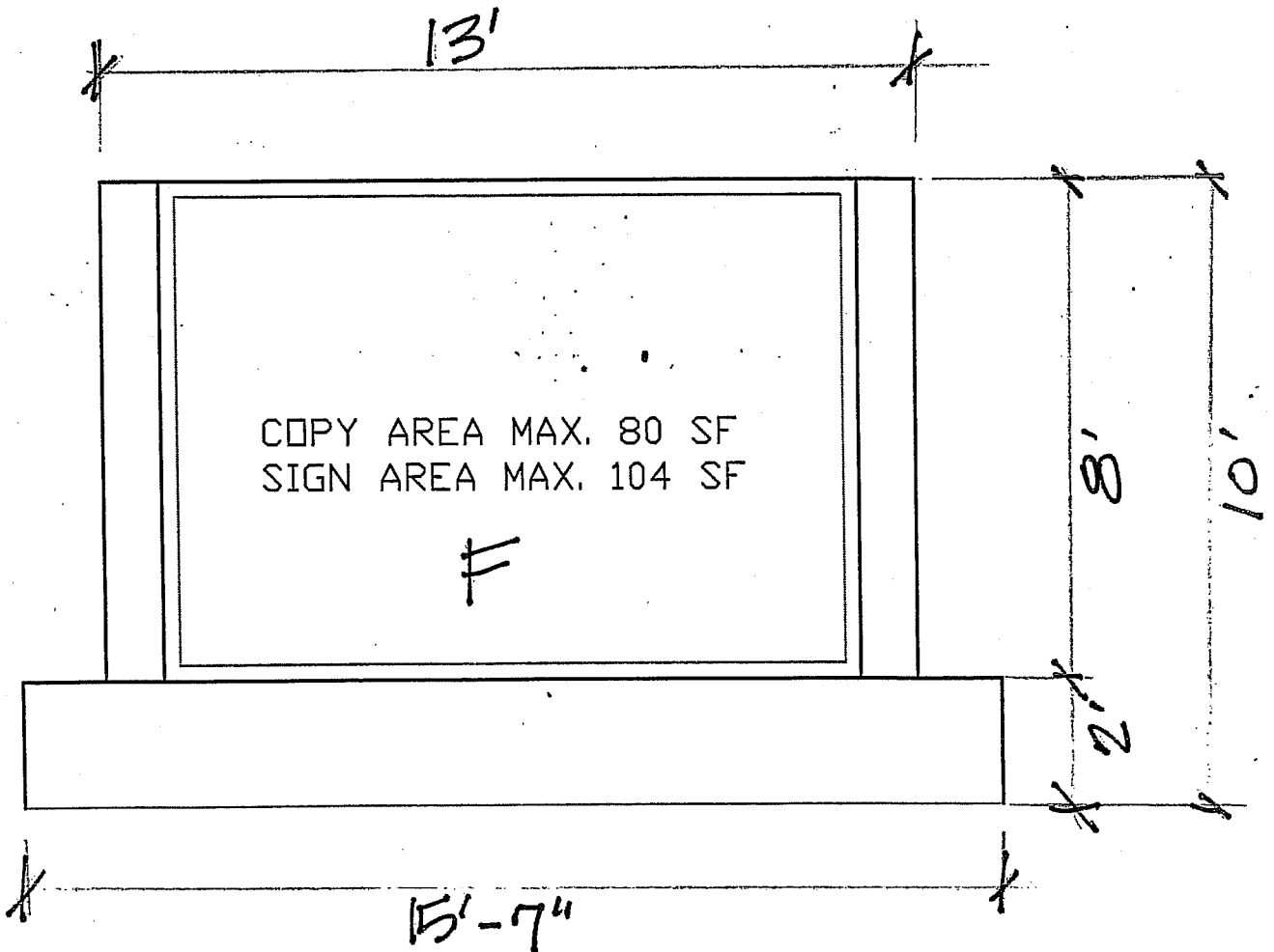

11-2008-0117012

11 = 30'

# ZERO SETBACK REGULATIONS

MET

SHOPPES AT MCGINNIS CROSSING SIGNAGE

24'-6"

COPY AREA MAX. 80 SF

SIGN AREA MAX. 104 SF

23'-4"

D

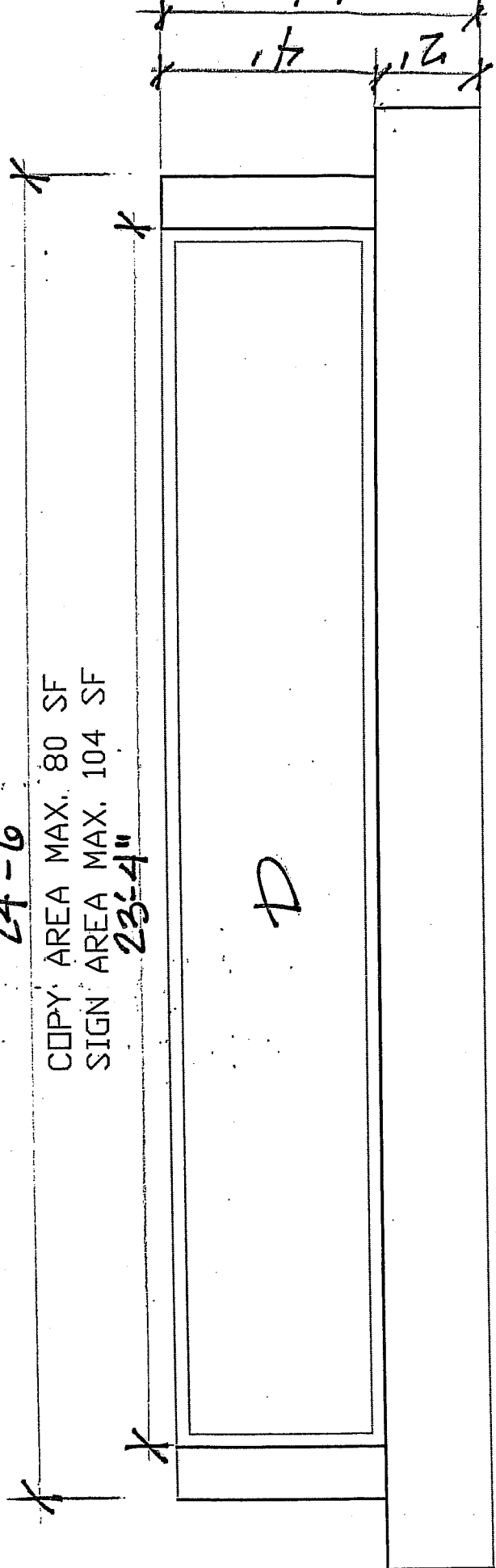

1" = 30'



SIGNAGE THAT MEETS  
REGULATIONS  
W/EXCEPTION OF HEIGHT

SHOPPES AT MCGINNIS CROSSING SIGNAGE

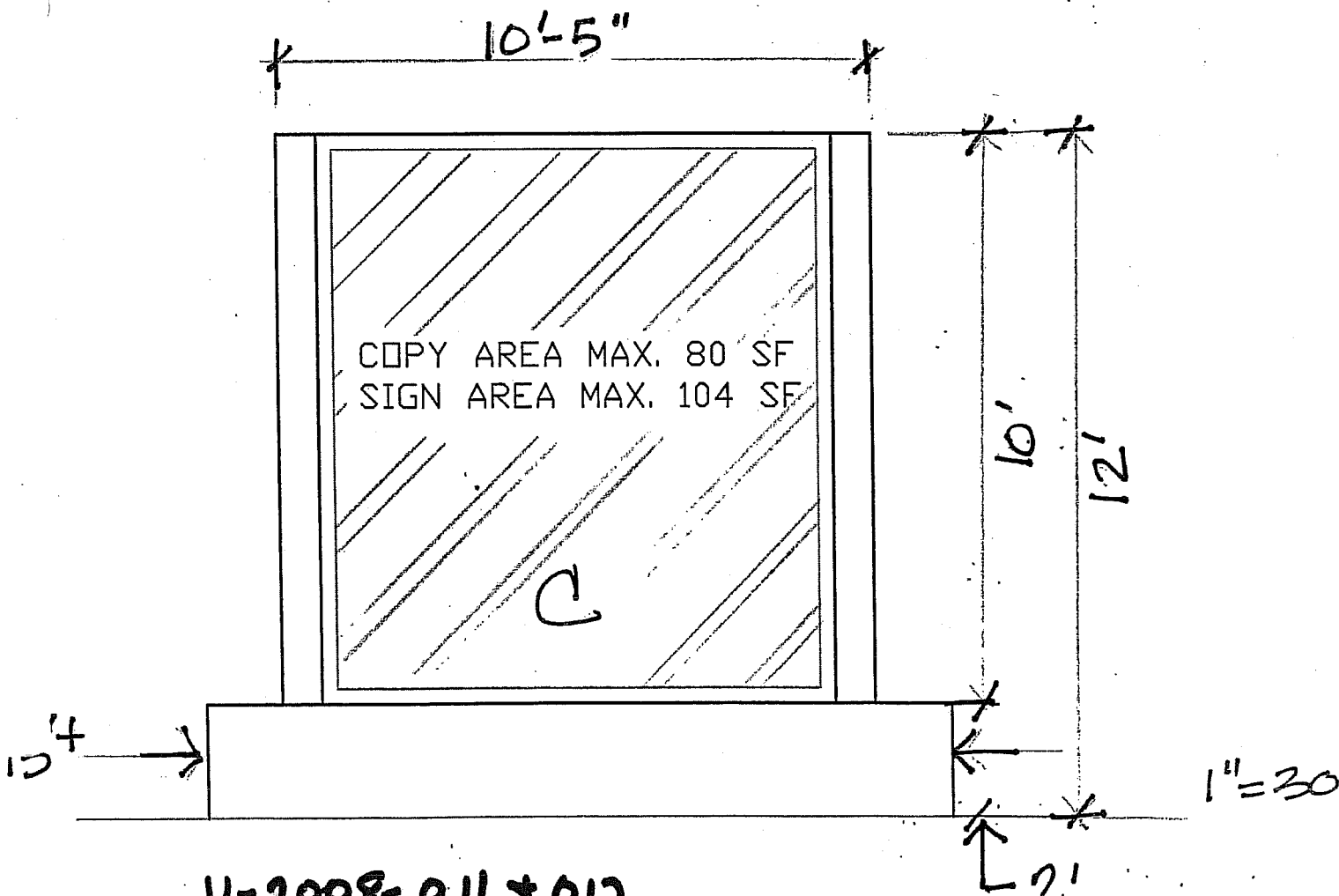

U-2008-011 + 012

10  
1

SKETCH OF SIGNAGE  
DESIRED THAT REFLECTS  
ARCHITECTURE OF THE  
SHOPPES AT MCGINNIS FERRY

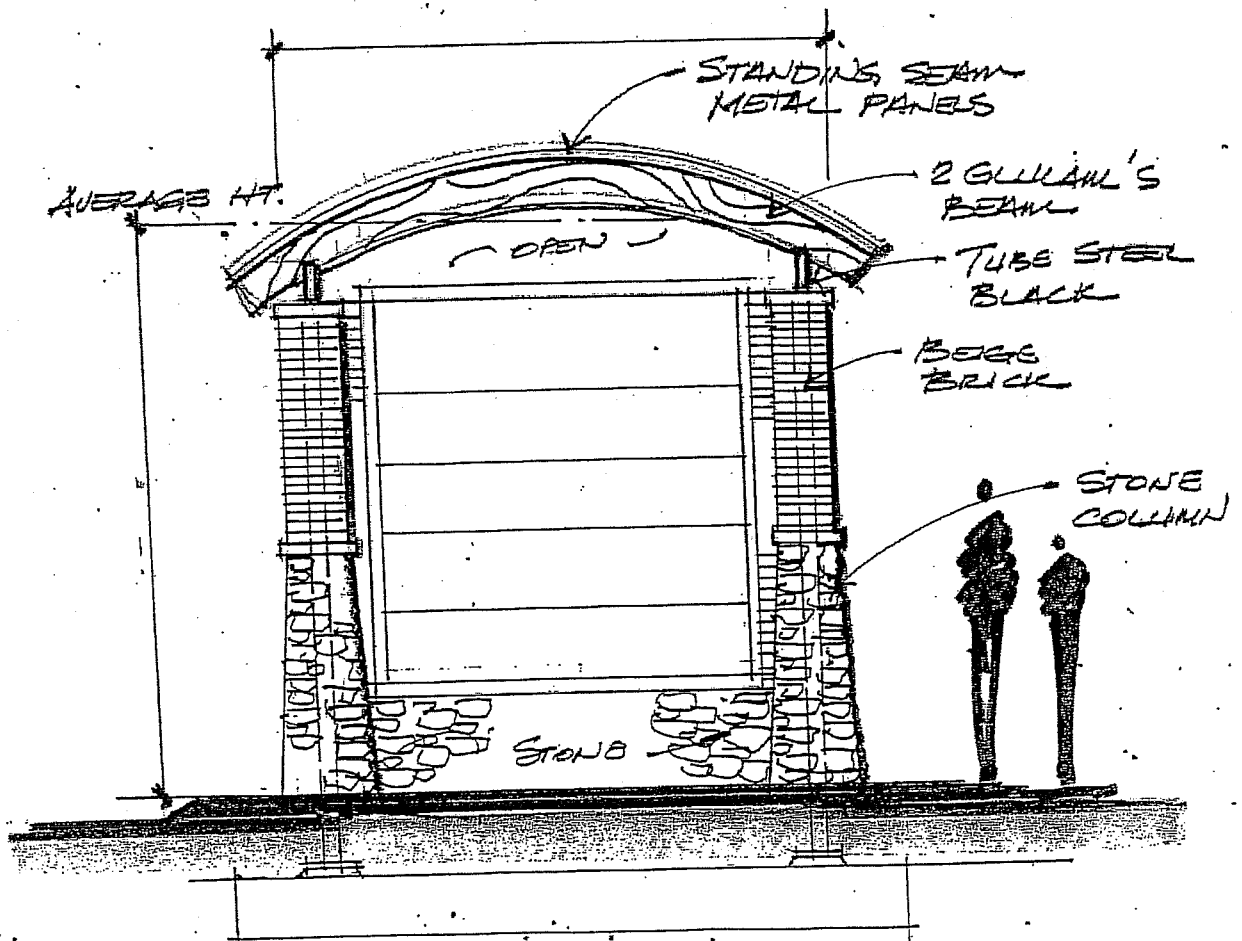

V-2008-011.012.013

DESIRED  
SHOPPES AT MCGINNIS CROSSING SIGNAGE

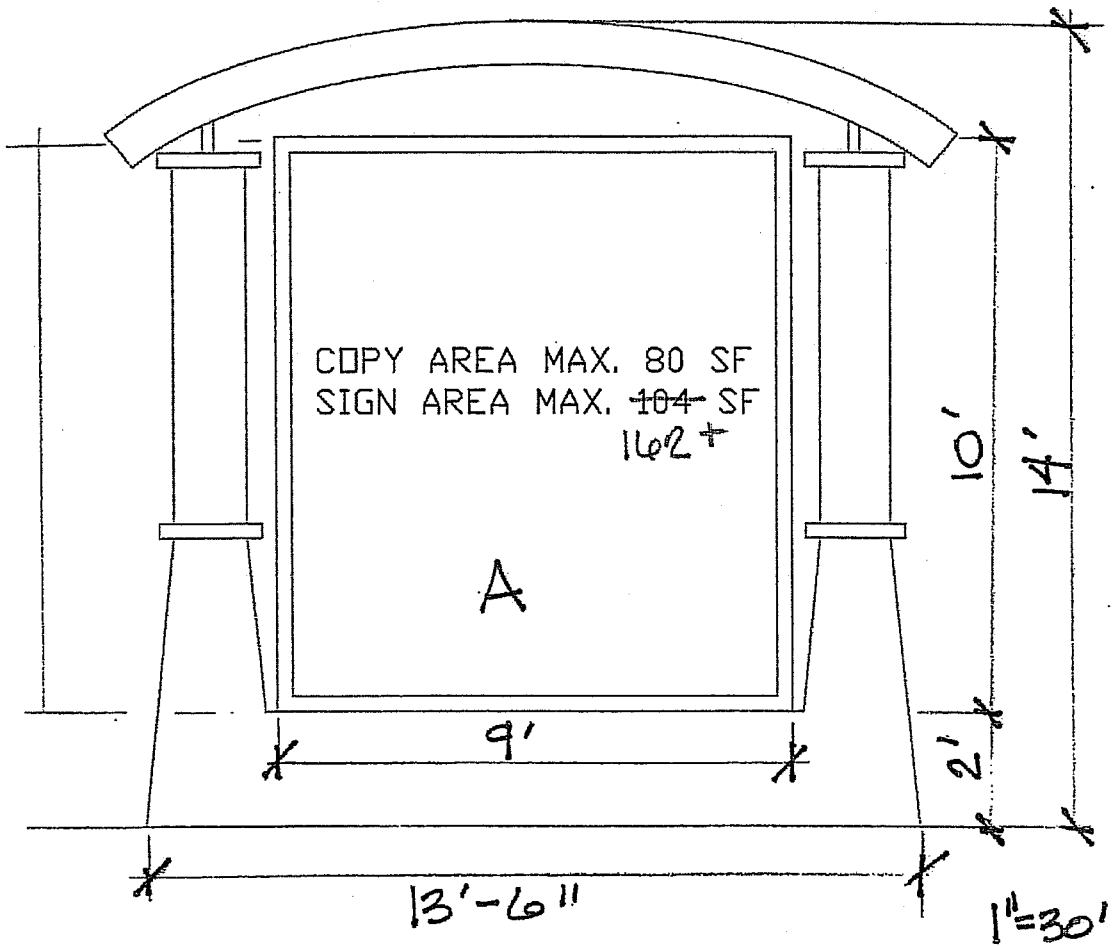

**VARIANCE EXHIBIT(S):**  
**V-2008-013**

DESIRED  
BRUNSWICK+ SIGNAGE

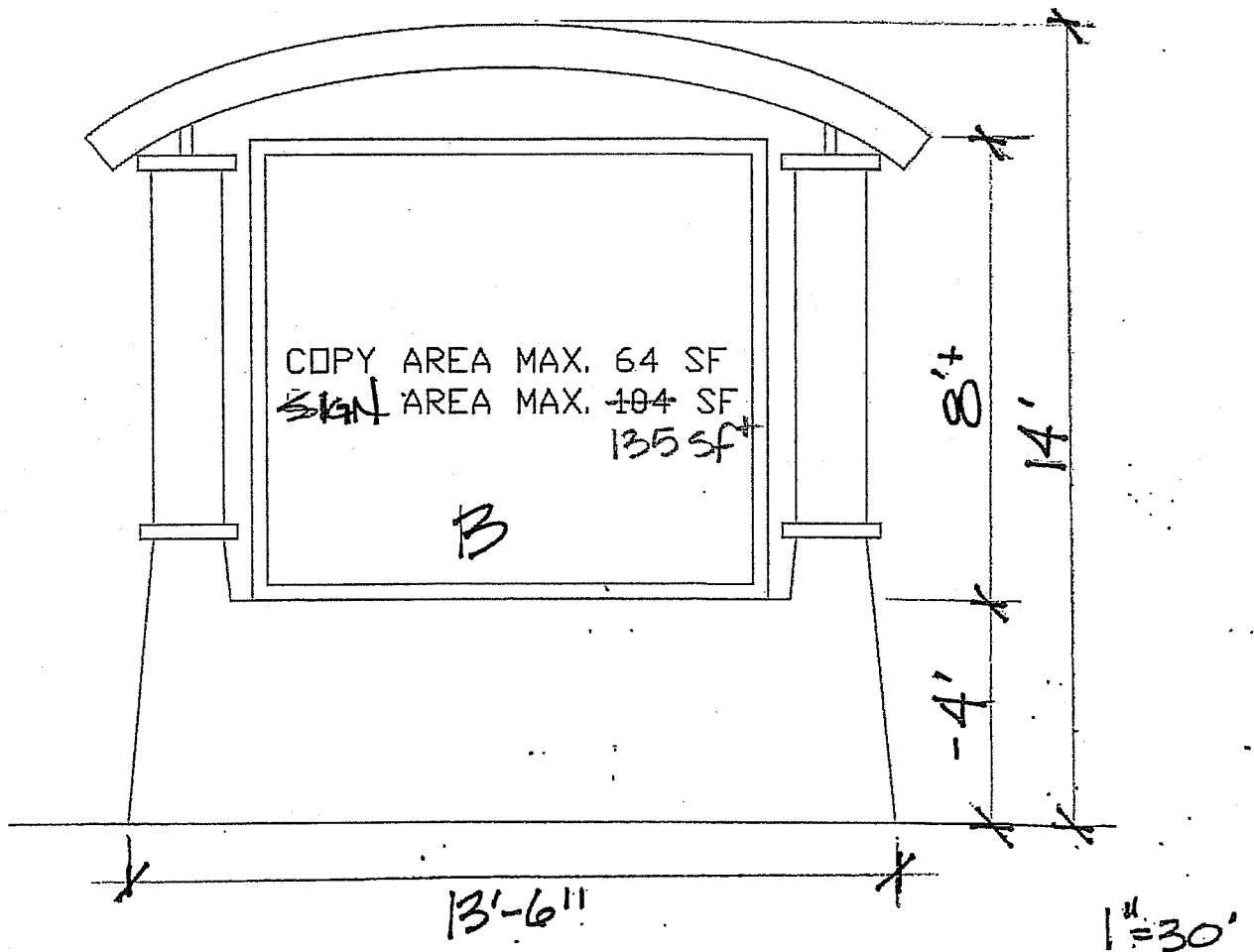

10  
1

# SKETCH OF SIGNAGE DESIRED THAT REFLECTS ARCHITECTURE OF THE SHOPPES AT MCGINNIS FERRY

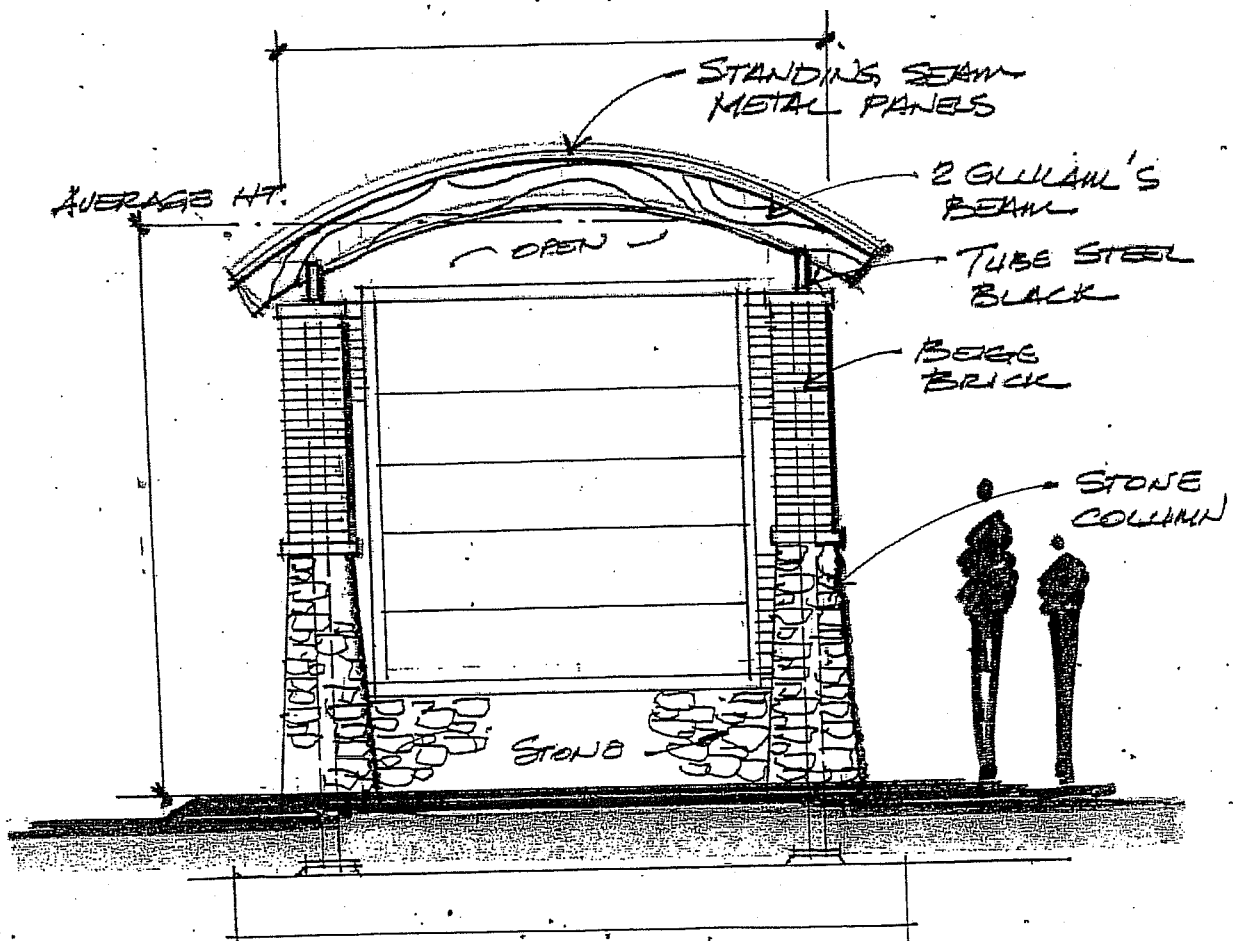

V-2008-011.012.013